

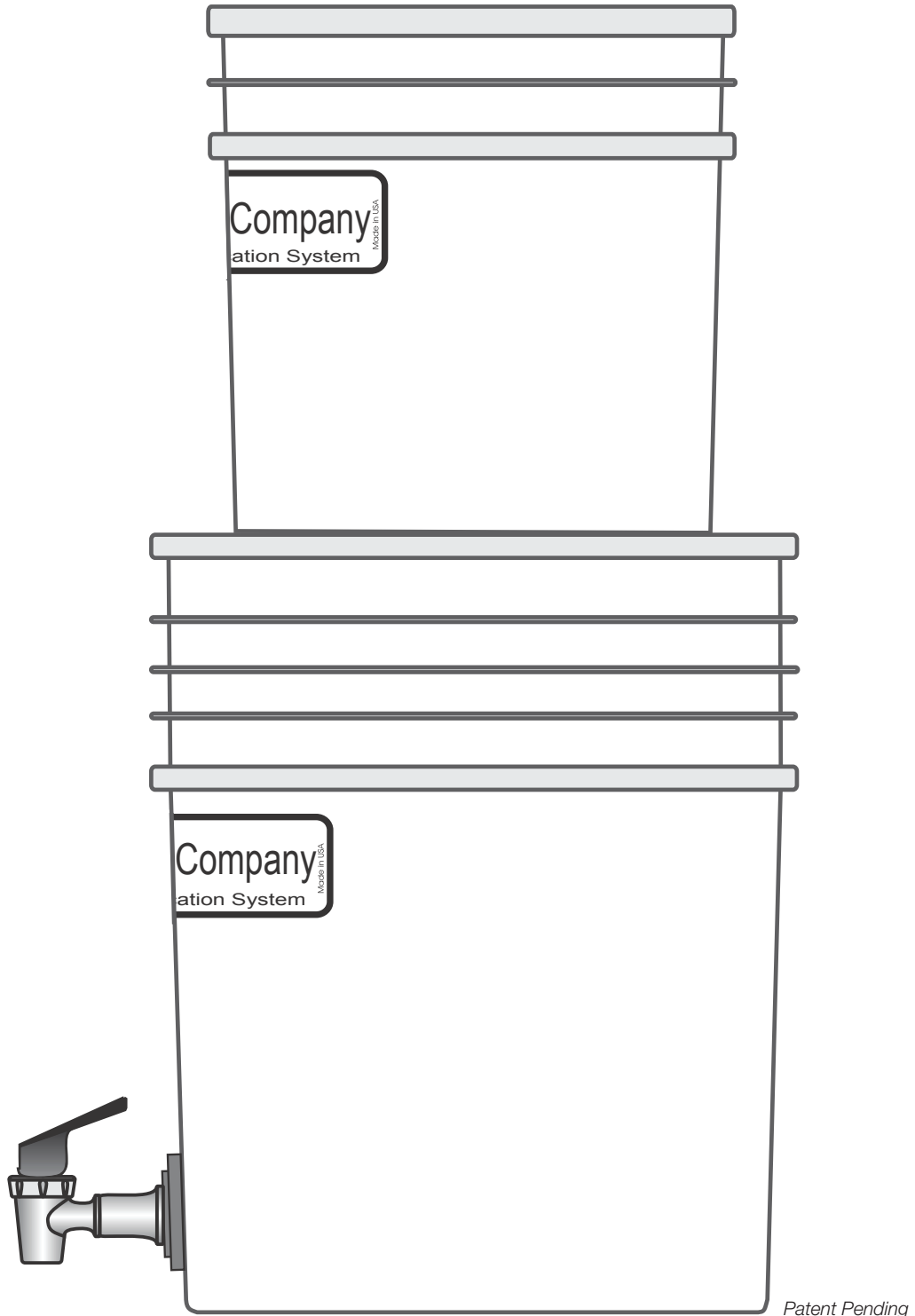

INSTALLATION AND OPERATING INSTRUCTION MANUAL



B. David Company

World Health Through Dynamic Filtration Systems



Congratulations!

Thank you for choosing the B. David Company Portable Water Filtration/Purification System!

How It Works

The WP-1924 is a portable pour through gravity-powered system that provides filtered and purified drinking water from virtually any fresh or moving water source.

Designed to be effective and convenient, the system will remove bacteria, cysts, virus and various chemicals and organic contaminants. It is an essential for camping, food storage, and in preparation for emergency or disaster situations. The B. David Pour-Through System has been proven effective by relief, missionary and government organizations in the United States as well as in Latin America, Africa, the Middle East and in Asia.

The system filters and purifies water in a four-stage process. First, a coarse cloth filter, stretched over the top of the source water pail, removes large sediment particles, turbidity, dirt, and debris. Then a filtration sleeve (surrounding the purification cartridge) removes any additional sedimentation and turbidity. Next, the nano filtration stage eliminates bacteria, cysts and virus. Finally, the Multi-media Cartridge absorbs chemicals, organic matter, environmental contaminants, pesticides, herbicides and other contaminants which can cause offensive tastes and odors. Leaving you with great-tasting clean drinking water.

Please take a few moments to read this manual to better understand how to properly assemble and maintain your new water purification system.

WP-1924

Pour-Through Water Purification and Filtration System

Fibrous Pleated Nano Filter

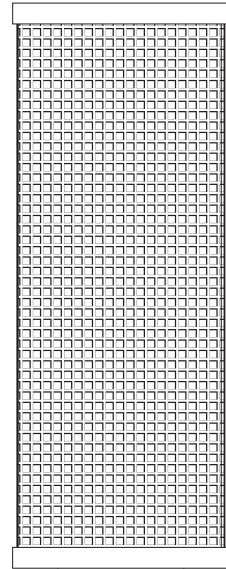

Multi-Media Removal Cartridge



BEFORE YOU BEGIN



Preparation

- Before you begin assembly of your new System it is very Important that you read through all of the instructions carefully.
- Improper assembly could damage the system and/or lead to the production of un-filtered and unpurified water.
- The assembly requires no tools.
- A standard 5 gallon bucket can be used to collect source water.
- Be sure to wash your hands thoroughly before handling system components.

What's Included in My Package?

1. Source Water Container Lid
2. Source Water Container (2 gal.)
3. Pre-Filter Net (WP-2040) •• (optional)
4. Sleeve for Fibrous Filter* (WP-2050) (optional)
5. Pleated Fibrous Nano Filter (WP-1803)
6. Gasket for top end of filter connector
7. Filter Connector (FC)
8. Gasket for Multi-Media Cartridge
9. Purified Water Container Lid
10. Purified Water Container (5 gal.)
11. Multi-Media Cartridge (WP-1802)
12. Spigot Assembly
13. Assembly and Operation Manual

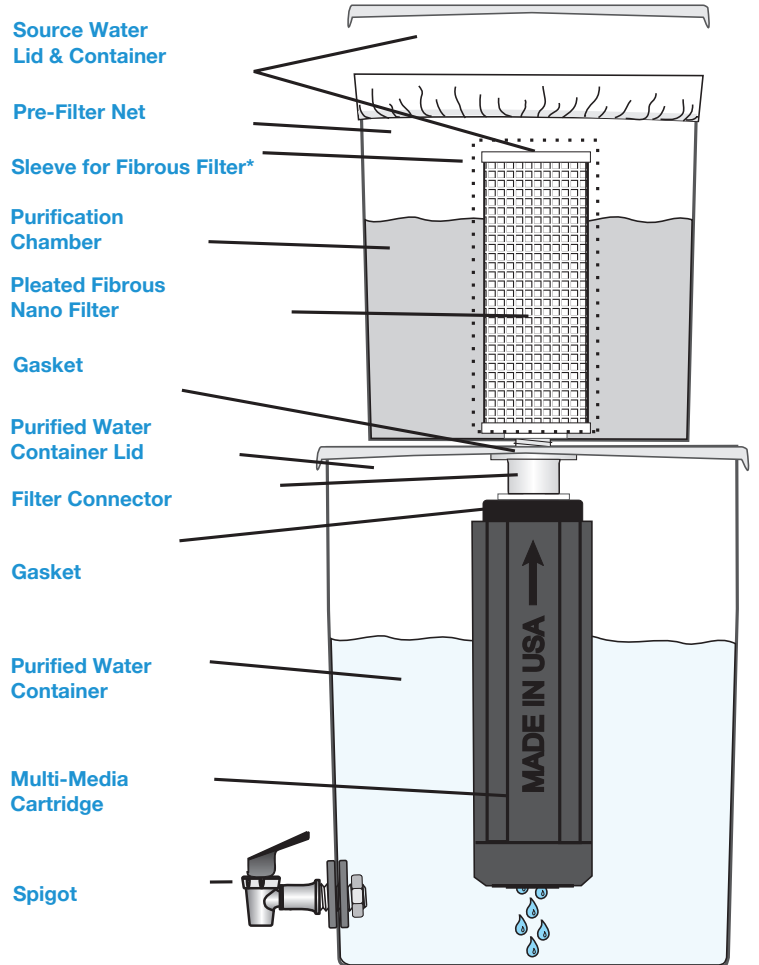
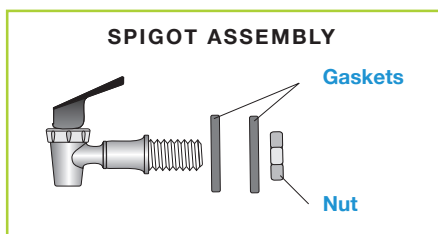

If you discover that your system is missing any of the specified parts, please contact the B. David Company for assistance before use.

ASSEMBLY

Assembling your new system is a simple process. Follow the detailed instructions and you will be enjoying clear, great-tasting water in a matter of minutes!



Begin the assembly by washing your hands with soap and water. Next remove the (blue) sanitary plugs from the lower spigot hole in the bucket and from the bucket lid. These plugs may be saved for use when unit is stored.

Always wash hands thoroughly with soap and water before handling system components.

1. Insert the spigot threads through one Gasket and through the spigot hole in the lower portion of the Purified Water Container. Slide the second spigot Gasket over the bolt then screw on the nut and tighten securely.

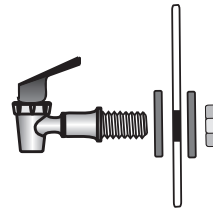

2. Insert the threaded end of the Filter Connector through the hole in the center of the lid.

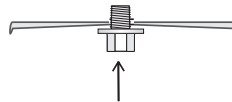

3. Place Source Water Container on the lid with the threaded end of the Filter Connector projecting through the hole in the bottom of the container.

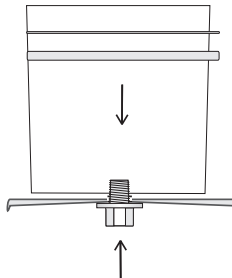

4. Place the smallest of the white Gaskets over the threaded end of the Filter Connector.

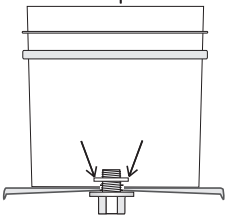

5. Thread the Pleated Fibrous Filter Cartridge onto the threaded end of the Filter Connector in the Source Water Container. Hand tighten until the end of the filter seats firmly against the Gasket and the Gasket against the bottom of the container.

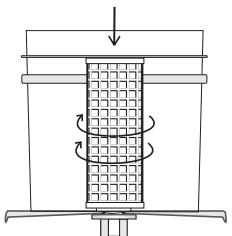

Before using system wash the Filtered Water Container to ensure removal of any contaminants introduced while being handled or stored.

6. If optional Filter Sleeve was purchased, slide it over Pleated Fibrous Filter and secure at bottom of filter with provided elastic.

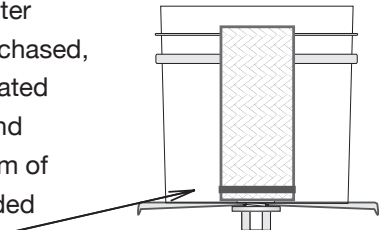

7. Place the larger white Gasket over the threaded end of the Multi-Media Cartridge.



8. Thread the Multi-Media Cartridge into the bottom of the Filter Connector. Seat cartridge firmly against Gasket and Gasket firmly against Filter Connector to create a snug fit. DO NOT OVER TIGHTEN.

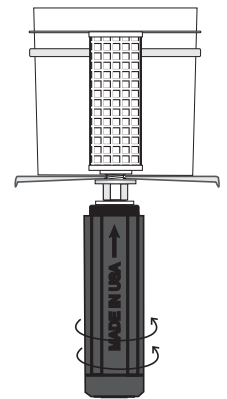

9. Place the assembly onto the Purified Water Container to prepare for operation and to prevent any debris from contaminating the purified water.

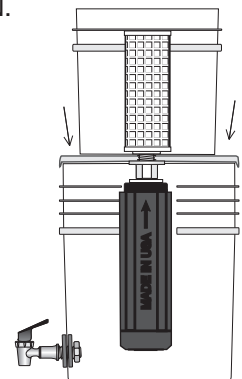

OPERATION



Purification Stages 1 and 2

1. Fill a collection pail with water from any tap, clear, moving, or freshwater source. (*Do not use hot, salt or brackish water*).

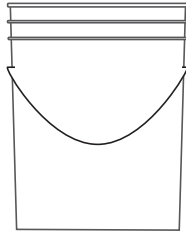

2. If Optional Pre-Filter Net was purchased, stretch it over the top of the Source Water Container, seating the elastic over the upper lip of the pail.

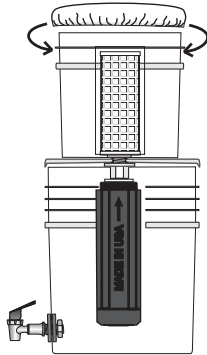

3. Pour the water through the Pre-Filter Net and into the Source Water Container. The Pre-Filter Net will filter large particles and debris from the source water. The Sleeve over the Pleated Fibrous Filter will remove sediment and particles up to 5 microns in size.

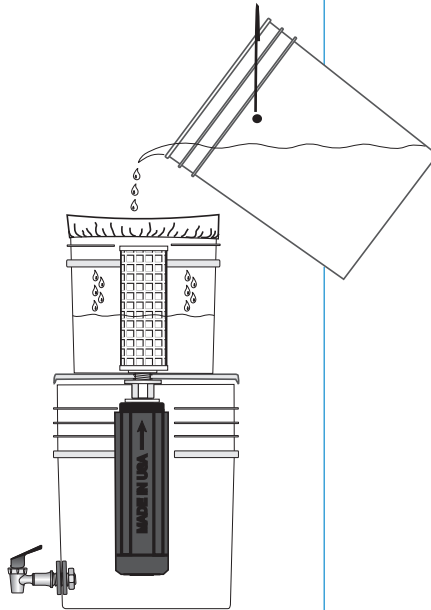

4. After you have poured water from the collection pail into the source water container cover the pail with its lid.

Hot water diminishes the system's filtration life.

Purification Stages 3 and 4

Once through the Pre-Filter Net gravity gradually pulls the water through the Pleated Fibrous Filter, removing cysts, bacteria and virus then down through the center of the Filter Connector. The water then enters the Multi-Media Cartridge where chemicals, pesticides, herbicides, organic matter and other contaminants are absorbed by the Multi-Media Cartridge, removing toxins, bad tastes and odors from the water.

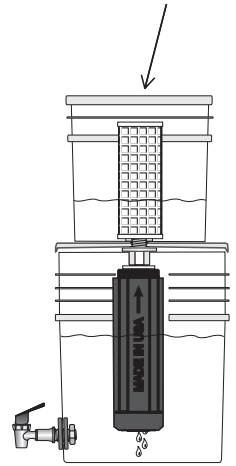

The water is ready to drink as soon as it enters the Purified Water Container. There is no need to wait for this container to fill beyond the level of the Spigot. just depress the Spigot (located near the bottom of the Purified Water Container) to dispense clear, filtered water.

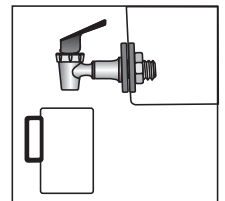

NOTE: *The first few gallons of filtered water may contain carbon fines – which appear black in color. These carbon fines are not harmful, but can be flushed rather than consumed. To flush, simply allow the first few gallons of water to pass, unused through the system, until the water runs clear.*

Remember: The clearer the source water, the longer your filters will last.

DISASSEMBLY FOR MAINTENANCE, FILTER REPLACEMENT OR STORAGE

For cleaning and maintenance, filter replacement, transportation or for ease of storage your system must sometimes be disassembled. To do so, follow the directions found below. Be sure to wash your hands thoroughly with soap and water before handling system components. (For more detail see assembly instructions on pages 4 and 5.)



1. Remove Pre-Filter Net and lift the entire assembly off of the Purified Water Container by the lid. The Source Water Container and cartridge assembly are all attached to the lid.

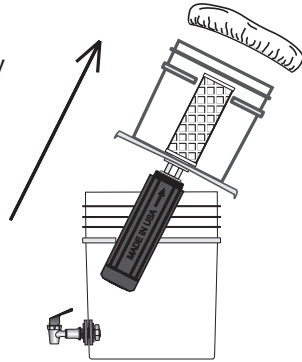

2. To remove the Multi-Media Filtration Cartridge unscrew it from the Filter Connector. Remove the Gasket from the lower end of the Filter Connector.

3. To remove the Pleated Fibrous Filter from the Source Water Container unscrew it from the Filter Connector while gripping the lower end of the Filter Connector. Remove the Gasket from the upper end of the Filter Connector and remove the Filter Connector.

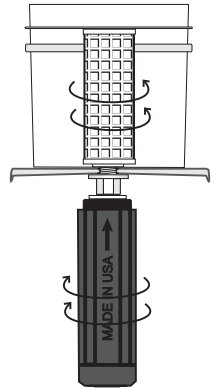

MAINTENANCE AND CLEANING

How often should I clean the system? The answer to this question varies greatly, based on the cleanliness of your operating conditions. In fairly clean conditions, it is recommended that you clean the system at least once a week. During emergency conditions the following is recommended:

Maintenance During Normal Use:

(IMPORTANT: To avoid contamination of the system wash hands and use clean materials whenever having contact with interior surfaces).

Daily:

Discard any unused water stored in the lower bucket for 72 hours or more.

Twice each week:

- a. Using filtered water, rinse any dirt from inside the Source Water Container.
- b. Rinse the Pre-Filter Net and Pleated Fibrous Filter and Filter Sleeve (if used) with clear water to remove any debris which may have accumulated.
- c. Use a cloth dampened with chlorine solution to wipe out the inside of all three containers and the spigot. This treatment of the Purification Container and the Spigot is particularly important. Use 1/2 teaspoon of household bleach (5.5-6% Chlorine Hypochlorite) per 5 gallons of water.
- d. Reassemble the system for operation.
- e. Wipe dirt or debris from the outside of the surface and rinse with clear, clean water.

NOTE: *With the exception of the pleated filter and multi-media cartridges, all other surfaces can be exposed to hot soapy water.*

General: *Track usage to ensure that filters are replaced at the required frequencies stated in the System Manual. Remember, the capacity depends upon source water.*

It is very important that your system be kept clean at all times. When cleaning the spigot, as well as the inside and outside of the pails, make sure to use a clean cloth dampened with chlorine. Used or dirty towels will expose the system to contaminants which can cause illness.

STORAGE



To store for brief periods of non-use (several days), flush the system thoroughly (at least 2 gallons) before and after the period of non-use.

If you are not planning to use the system for an extended period of time (several weeks, months or more) the Pleated Fibrous Filter and Multi-Media Cartridge must be replaced before re-using the system.

1. Run clear water through the system to flush the cartridges.
2. Remove the Filter Cartridges from Filter Connector and allow them to drain and dry. The Pre-Filter Net and Filter Sleeve should also be dry before storage.
3. Rinse and wipe the system out according to the maintenance instructions on the previous page and wipe dry with a clean soft cloth. Remember to wipe the outside of the source water container as well.

Note: As you un-assemble unit remember to place all cleaned components and filters on a clean surface to avoid contamination.

4. Remove Spigot and associated washers and nuts.
5. Replace the sanitary caps in the holes left by the Filter Connector and the Spigot.
6. Place the Spigot and Spigot parts, Gaskets and Filter Connector in a re-sealable plastic parts bag.
7. Place the Pre-Filter Net, Filtration Sleeve, Multi- Media Cartridge, the Pleated Fibrous Filter and the bag containing the Spigot, Gaskets and Filter Connector into the Source Water Container.
8. Place the lid on the Source Water Container and, after wiping down the outside, place it inside the Purified Water Container.
9. Place the lid back onto the Purified Water Container to protect contents from contamination.
10. Place the system in its box.

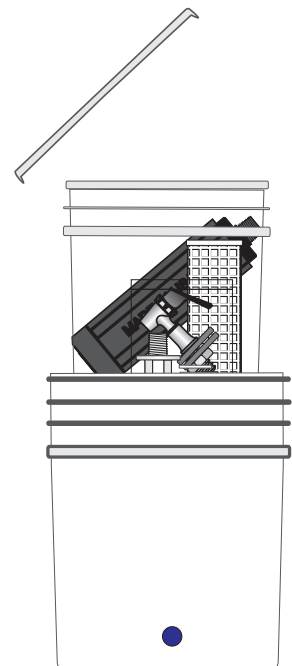

This system is now fully un-assembled and ready for storage or transport.

Remember: After storage or transport clean the spigot and the interior of the purified water container before using it. Moisture from the sediment pre-filter and/or the source water container can contaminate it when In the “stored” position.

CHANGING CARTRIDGES



When should I replace the Filter Net?

Item: WP-2040

The Pre-Filter Net is very durable and can be cleaned and re-used repeatedly. It should be replaced when there is indication of wear that would reduce its effectiveness in screening unwanted debris from the source water. This include fraying, noticeable change in weave or exhaustion of the elastic used to hold it on the source water pail.

When should I replace the Filter Sleeve?

Item: WP-2050

The Filter Sleeve can be rinsed to eliminate debris and improve flow rate however if rinsing does not improve flow rate it should be replaced.

When should I replace the Pleated Fibrous Purification Filter?

Item: WP-1803

Replace after 12 months or if there is a noticeable reduction in flow rate that cannot be resolved by taking the following steps:

1. Remove the Pleated Fibrous Filter from the Filter Connector.
2. Hold the filter horizontally by its end-caps, and GENTLY tap it on a hard surface. Rotate and repeat several times. This may loosen any larger particles trapped in the filter's surface.
3. Rinse the filter with clear water to remove any debris it may have accumulated.
4. Re-connect the filter to the Filter Connector inside Source Water Container.
5. If water flow is still slow, replace the used Pleated Fibrous Filter with a new one- attaching it as pictured.

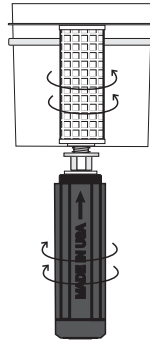

When should I replace the Multi-Media Filter Cartridge?

Item: WP-1802

After approximately 6,500 liters (1,800 gallons)*/12 months of use, you may need to replace the Multi-Media Filtration Cartridge. If you notice any changes in taste and/or odor, this is also a good indication that the Multi-Media Cartridge is in need of replacement. To replace the cartridge please follow the detailed steps found below:

1. Lift the lid assembly off of the purified water container. The source water container and cartridge assembly are attached to this lid.

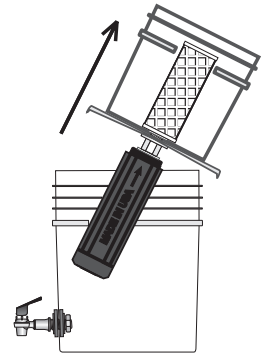

2. Un-screw the Cartridge from the Filter Connector on the bottom side of the lid. Discard the used cartridge as you would your normal trash. (Be careful to remove the gasket from the threaded end of the cartridge and save it for use with the new cartridge.) Thoroughly wash the system with filtered water. Be sure to clean the entire system before installing a new filtration cartridge.

3. Place the gasket (reserved in step 2) over the threaded end of a new Multi-Media Filtration Cartridge. Screw the cartridge onto the Filter Connector by turning it clockwise (by hand only).

4. Flush the new cartridge by allowing water to flow through the system until it runs clear. This will remove any loose carbon fines from the carbon stage of the Multi-Media Cartridge. Although carbon fines are completely harmless new cartridges should be flushed thoroughly before use.

Be sure to clean the entire system before installing a new filtration cartridge.

SPECIFICATIONS AND REPLACEMENT PARTS

Replacement Parts



Item#	Parts Description	Placement
WP-2040 (optional)	Pre-Filter Net	Over Source Water Container
WP-1803	Pleated Fibrous Purification Filter	Source Water Container
WP-1802	Multi-Media Filtration Cartridge	Purified Water Container
FC-Gasket 12	1/2" Filter Connector Gasket N	Nipple end of Filter Connector
FC-Gasket 34	3/4" Filter Connector Gasket	Nipple end of Multi-Media Cartridge
WP-2050 (optional)	5 micron Pre-Filtration Sleeve	Over WP-1803 Pleated Fibrous Filter

Wash and sanitize Purified Water Container before installing new cartridges and after handling it's interior for any purpose.

WP-1924 Specifications***

DIMENSIONS	American Standard Assembled: 24" x 11.75" Boxed: 18" x 12" x 12"
WEIGHT	Boxed: 8.00 lbs. Empty: 6.75 lbs. When filled with water: 45.50 lbs.
CUBE	1.5 ft ³
FLOW RATE*	6-12 Gallons/Day (depending on water conditions)
CAPACITY**	1.800 Gallons** or diminished flow
OPERATING TEMPERATURE	42°F to 125°F
CARTRIDGES	7 " Pleated Fibrous Purification Filter (WP-1803) 10" Multi-Media Filtration Cartridge (WP-1802)
APPLICATIONS	Fresh or Moving Water Only

* Highest flow rate can be achieved by keeping upper bucket full to maintain maximum gravity pressure on filters

** Capacity or life expectancy of the filter cartridges may vary depending on the quality of the source water

*** Specifications and capacities are subject to change without notice.

TROUBLESHOOTING

The following list includes situations that may occur during your use of the system. If, after reviewing this list, you are still unable to repair or solve a complication, please contact your local distributor for assistance.



SITUATION	SOLUTION
Black dust in the water	The black dust consists of loose particles of activated carbon that may be rinsed out of the multi-media cartridge by flushing water through it. These particles are NOT harmful.
“Flakes” in cold water	Higher concentrations of natural minerals in the water will solidify into “flakes” or “specs” when the water becomes frozen, then melts. These same minerals can also leave a deposit on pots when water is boiled. Natural minerals are beneficial, and the visible presence of them should be of no concern.
Slow flow rate	The pleated filter or multi-media cartridge may be plugged. First, check the Pleated Filter using the following steps: <ol style="list-style-type: none"> 1. Remove the source water pail and the double lid (with the filters attached) from the system. 2. Remove the pleated filter from the filter connector. 5. Clean and rinse the pleated filter following the steps located on page 8 of this manual. 3. After cleaning the pleated filter, reinstall it and run water through the system once more. 4. If there is little or no water flow, replace the pleated filter with a new one. 5. Reinstall the multimedia cartridge and check the flow rate. 6. If the flow rate is still too slow, the system requires a new multi-media cartridge.
Unusual taste	If an unusual taste develops in your purified water, the multi-media cartridge’s ability to absorb bad tastes is approaching its capacity. A new multi-media cartridge should be installed.

Do NOT use a filtration cartridge that is cracked or broken.
Do NOT use a filtration cartridge longer than the capacity stated in this manual.
Please contact your local dealer for replacement parts.

LIMITED WARRANTY



The B. David Company warrants that the product sold hereunder will be free from defects in materials and workmanship under normal use for one year. The purchaser's sole remedy shall be repair or replacement of the defective component. The B. David Company will, at its discretion, repair or replace a defective product, FOB Bloomington, MN, provided that it is returned with proof of purchase to The B. David Company, postage prepaid, within the warranty period set forth above. All returns to The B. David Company require a Return Authorization Number.

This Limited Warranty will not apply to any product which has been altered, incorrectly installed, misused, abused or used for any other application other than personal household use; The B. David Company specifically disclaims any warranty of any kind on such products.

THE LIMITED WARRANTY SET FORTH ABOVE IS IN LIEU OF ALL OTHER WARRANTIES, WHETHER EXPRESS OR IMPLIED, INCLUDING ANY IMPLIED WARRANTY OF MERCHANTABILITY OR FITNESS FOR A PARTICULAR PURPOSE. THE B. DAVID COMPANY SPECIFICALLY DISCLAIMS ANY RESPONSIBILITY OR LIABILITY FOR INCIDENTAL OR CONSEQUENTIAL DAMAGES.

For a return authorization number or questions contact the B. David Company.

